



Flexibility in Perfection

Schunk Ensures Maximum
Process Reliability
Through Nc Simulation
With Vericut



User Story

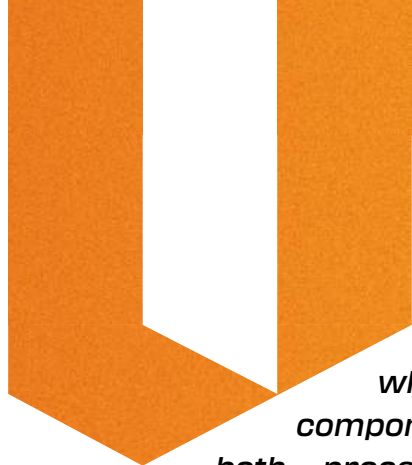

When it comes to process optimization in industrial production, it's hard to overlook the gripping and clamping technology specialist Schunk. The family-owned company stands out for its innovation, top quality, and solution expertise. This is also reflected in their own manufacturing, where the team works daily to produce the best possible components and products on high-quality machine tools, ensuring both process reliability and economic efficiency. Alongside CAM programming and automation, the simulation of manufacturing tasks before real machining, using Vericut, plays a crucial role.

Engineer Robert Fraunberger, x-technik

When it comes to equipping robots and production machines, Schunk is a go-to partner for many industries worldwide. Whether it's smartphones, airplanes, vehicles, machines, knee joints, or nasal sprays: high-tech components from Schunk are often key players in their production.

Founded in 1945 by Friedrich Schunk as a small mechanical workshop, today Schunk is an international technology company with 3,700 employees in over 50 countries and is led by the third generation of the family, Kristina I. and Henrik A. Schunk. The family-owned company boasts extensive expertise in clamping technology for tools and workpieces, gripping technology, and automation technology. "Our components, applications, and services support our customers and partners globally in process optimization," emphasizes Fatih Gülgönül, Head of Engineering. He adds, "In addition to individual high-tech components, we provide intelligent complete solutions for robotic systems as well as for various production and automation processes—all from one source for custom client applications."

High Manufacturing Depth, High Quality Standards

Due to its extensive product portfolio of over 13,000 standard components and 2,000 customer-specific parts, Schunk's main production sites in Lauffen and Hausen—north of Stuttgart—emphasize high manufacturing depth. "For us, each step of the process must deliver maximum efficiency with the highest quality. That's why we keep all necessary competencies in-house and control every process step ourselves," says Production Manager Steffen Gotzmann, highlighting the importance of in-house manufacturing at Schunk.

At the Lauffen plant alone, about 250 skilled workers and over 150 CNC machines work in three shifts to efficiently produce various components, mainly for clamping technology, from different materials. A walk through the

production halls offers a great insight into Schunk's high-quality standards. In addition to well-organized production lines, the cleanliness and orderliness of workstations stand out. Whether turning, milling, grinding, or eroding, only top-tier machines from leading manufacturers are used.

"All core machines in our main production lines are CAM-programmed. This keeps downtime to a minimum," says Gotzmann. Schunk employs a total of 68 CAM programmers—nine of whom focus on custom clamping technology for smaller batches and order-specific production. "In this department alone, we create around 3,000 NC programs annually for approximately 2,000 custom-developed, designed, and produced products," Gülgönül explains.

Process Reliability is Key

For both department heads, maximum process reliability is critical for a cost-effective production process, as waste is something Schunk cannot afford. Alongside CAM programming and automation, the simulation of production tasks before actual machining plays a significant role. "Machine simulation is a key element for a safe machining process. The simulation integrated into the CAM system is not enough for us. It's crucial that the simulation we run in the office perfectly matches the real processes on the machines, including the kinematics of the equipment. Only then can we ensure that what we've programmed will be executed exactly as intended," Gülgönül explains why Schunk uses the Vericut simulation and optimization software.

"Vericut provided the complete package: the software delivers exactly what we need for efficient and safe production, and the Vericut team offers reliable support with their expertise," explains Steffen Gotzmann. CAM administrator Juri Buling adds: "When machines are idle, it costs a lot of money, and we want to avoid that. That's why investing in Vericut was the logical step." With Vericut, the entire clamping situation—including the blank, clamping tools, machining tools, and the machine itself—can be simulated. According to Buling, this virtual machining process has significantly increased process reliability in Schunk's production.

An Integral Part of the Process Chain

A key feature of Vericut, according to Hans Erkelenz, Managing Director of CGTech Germany, who led the project, is the fully independently developed software: "Since 1988, Vericut has been considered a benchmark in machining production, leading the field in machine simulation, verification, and optimization for all types of CNC machining, as well as additive and hybrid manufacturing processes. The software operates independently and integrates with all common CAM systems." Moreover, its core simulation engine is the fastest and most accurate in the NC

simulation field.

Currently, Schunk simulates 34 machine tools with Vericut in Lauffen: “We can simulate and optimize all our machines, including automated multi-channel turn-mill centers—with 100% accurate kinematics. We can also simulate features like engraving or transferring parts from main to counter-spindle—so Vericut is an essential part of our process chain,” says Buling. Erkelenz adds: “Vericut simulates the real machine environment with precise multi-axis and high-speed movements, multiple setups, and complex tool shapes, providing insights into potential collisions with holders or fixtures.”

Minimized Setup and Downtime

Due to the wide variety of customer-specific solutions at Schunk, frequent setups are necessary. “Thanks to CAM programming and Vericut simulation, we manage to keep these setup and downtime as low as possible. The NC program is already prepared on the machine, and we know it works because we’ve verified it with Vericut,” Gotzmann explains. This allows Schunk to use available resources as efficiently as possible.

According to the production manager, having a verified NC program also gives machine operators more confidence, allowing them to run new parts faster and more effectively. “Not to mention that we can optimize programs through Vericut without having to test them directly on the hardware—a significant advantage in times when continuous productivity increases are essential to remain competitive.” Optimizing NC programs is especially crucial for series parts.

Project Timelines Met

Since implementing Vericut, collisions have been eliminated at Schunk, and unnecessary costs due to downtime are avoided. “The project was challenging, so it’s all the more remarkable that Vericut fully met the timeline,” emphasizes Fatih Gülgönül. “Schunk is undoubtedly a special client for Vericut due to its scale and tight schedule,” notes Erkelenz. “Thanks to excellent support from Schunk, we were able to integrate the first 30 machines into the simulation within a year—this was challenging for our entire team! I’m proud we were able to meet all expectations 100%.”

The next steps for Schunk are already clear, as Buling concludes: “Our goal is to increasingly digitize all production sites and equip them with Vericut—ultimately securing our competitiveness.”

The family-owned company Schunk is managed by siblings Kristina I. and Henrik A. Schunk in its third generation. Founded in 1945, today the company develops, produces, and distributes top-tier automation technology, gripping technology, tool and workpiece clamping systems, as well as depaneling machines. With over 3,700 employees across seven plants and 34 subsidiary companies, Schunk ensures precise, economical, and reliable production worldwide. Its customers include the who's who of machine and plant engineering, robotics, automation and assembly handling, the automotive industry and its suppliers, as well as the electronics sector.



- 3,700 employees
- 7 production sites
- 34 country subsidiaries
- Over 13,000 standard products
- Over 2,000 custom solutions

Schunk SE & Co. KG
Bahnhofstraße 106-134,
D- 74348 Lauffen am Neckar
Tel.: +49 7133-103-0
www.schunk.com

Other companies:

DMG Mori, Zeiss (Note: visible in the images)

Summary

- **Task:** Simulation of NC code prior to actual machining.
- **Solution:** Vericut simulation and optimization software.
- **Benefit:** Maximum process reliability; reduced setup and downtime; no collisions due to programming errors; faster part setup times; quicker part production through NC code optimization, especially for series parts.

Statements:



The collaboration with Vericut was very satisfying - from sales to technical support.

**Fatih Gülgönül, Head of NC Programming,
Schunk SE & Co. KG**



In addition to CAM programming and automation, the simulation of manufacturing orders with Vericut before real machining plays an important role.

**Steffen Gotzmann, Production Manager,
Schunk SE & Co. KG**



When our machines are down, it costs a lot of money - by using Vericut, we can avoid this as much as possible.

Juri Buling, CAM Administrator, Schunk SE & Co. KG



Due to the scale and tight timeline, the project at Schunk was very special for us. It makes me proud that we were able to meet all expectations 100%.

**Hans Erkelenz, Managing Director,
CGTech Germany GmbH**

Product Areas:

- Automation Technology
- Gripping Technology
- Tool Clamping Technology
- Workpiece Clamping Technology
- Depaneling Technology



Currently, 34 machine tools at Schunk are simulated with Vericut, including automated and multi-channel turning-milling centers such as the CTX gamma 2000 TC from DMG Mori.

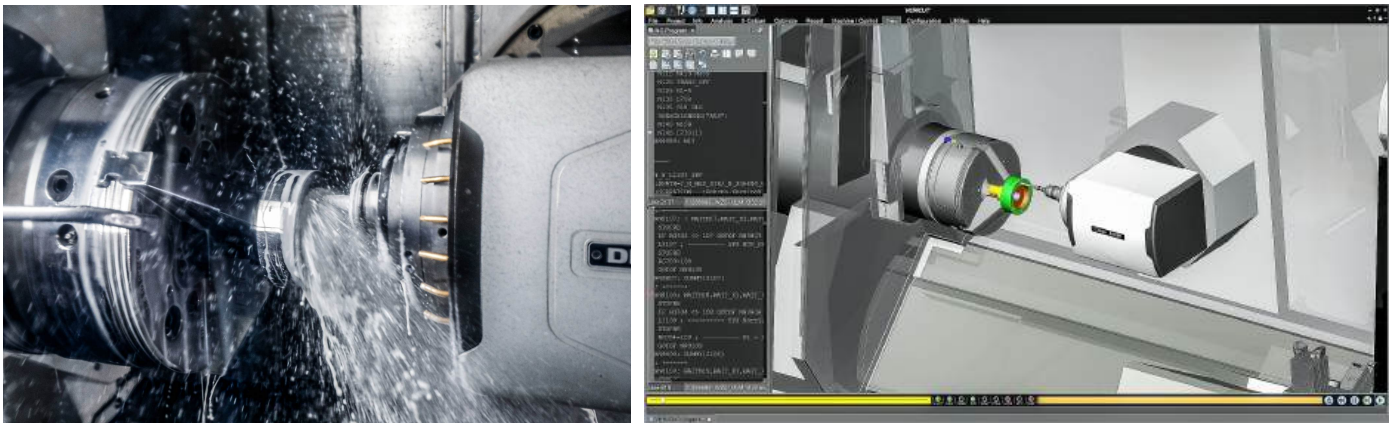

Vericut simulates the original NC code after the post-processing run. For Schunk, this is the only safe way to simulate the real machining situation with a "virtual machining machine on the desk."

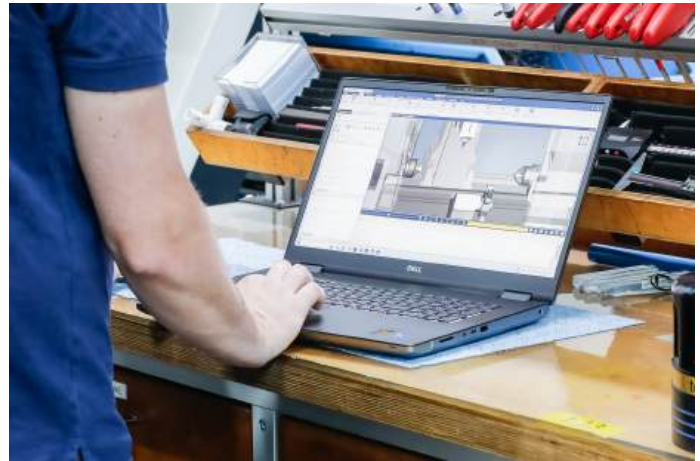

With a verified NC program, workers are also provided with more security, enabling them to be faster and more efficient when setting up new parts.



For Schunk, the support from Vericut was outstanding. Pictured are CAM programmer Kevin Gimber (left) and Hans Erkelenz.

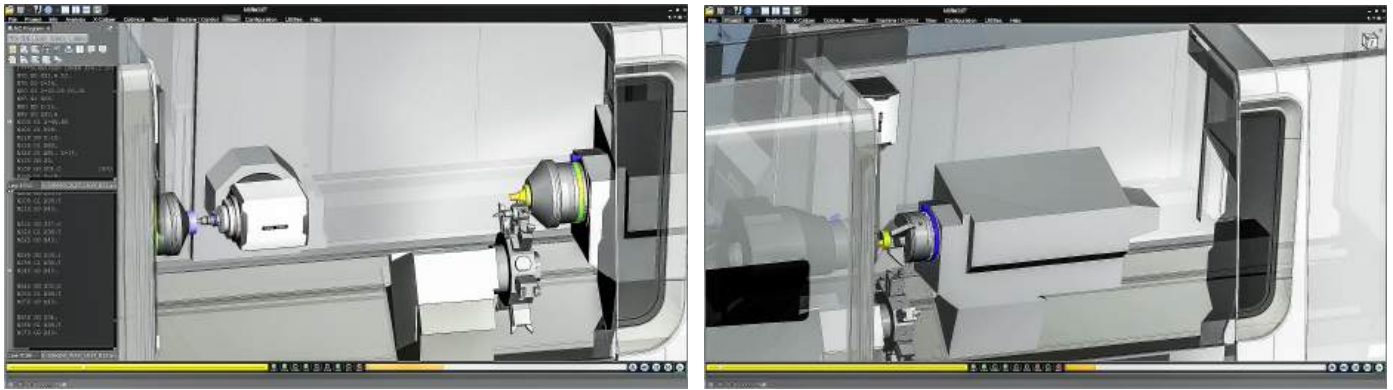

Especially with complex machine tools, collisions can occur repeatedly. At Schunk, these have been a thing of the past since the implementation of Vericut.



At Schunk, manufacturing processes are automated and digitized as much as possible, with process security always taking precedence.

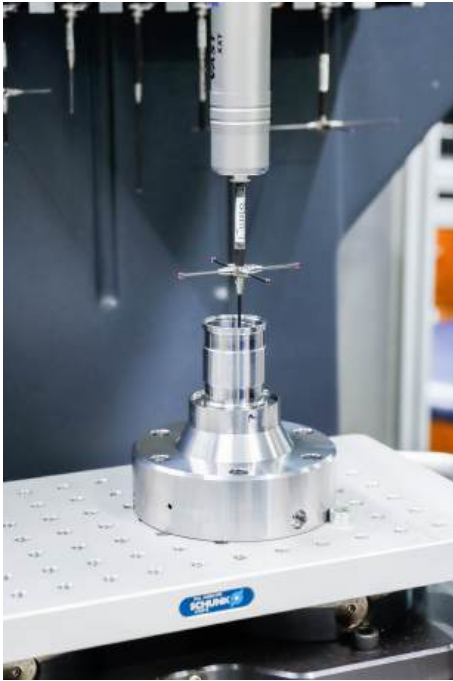

SchUNK stands for innovation, the highest quality, and problem-solving expertise.



Hand in hand for tomorrow: This claim also describes the collaboration between Schunk and Vericut. Pictured are Fatih Gülgönül, Juri Buling, Hans Erkelenz, and Steffen Gotzmann (from left to right).



Hans Erkelenz (left) and Steffen Gotzmann are in regular contact.



In addition to CAM programming and automation, the simulation of manufacturing orders plays a crucial role at Schunk before actual machining.

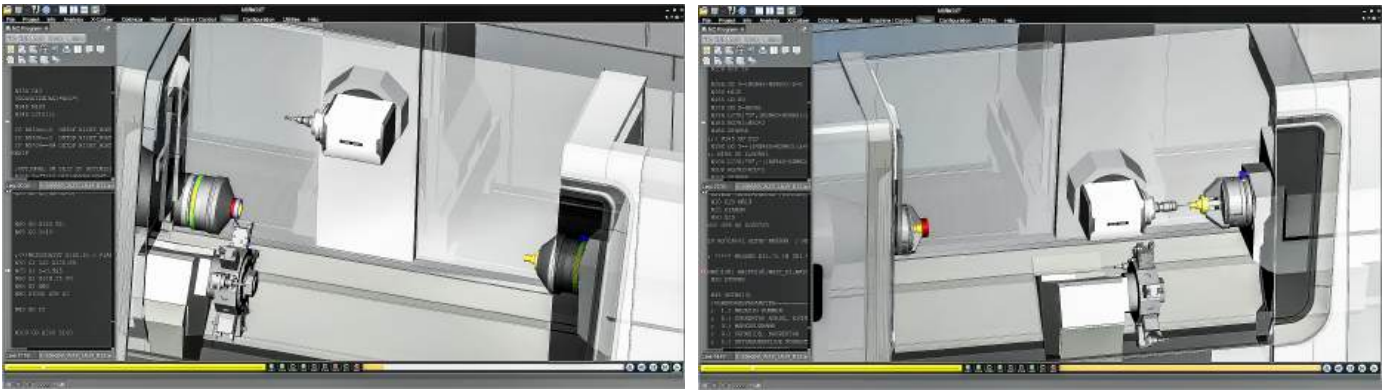

With Vericut, Schunk can simulate the entire clamping situation, including the raw material, clamping tools, cutting tools, and, of course, the machine tool, including the finished part.

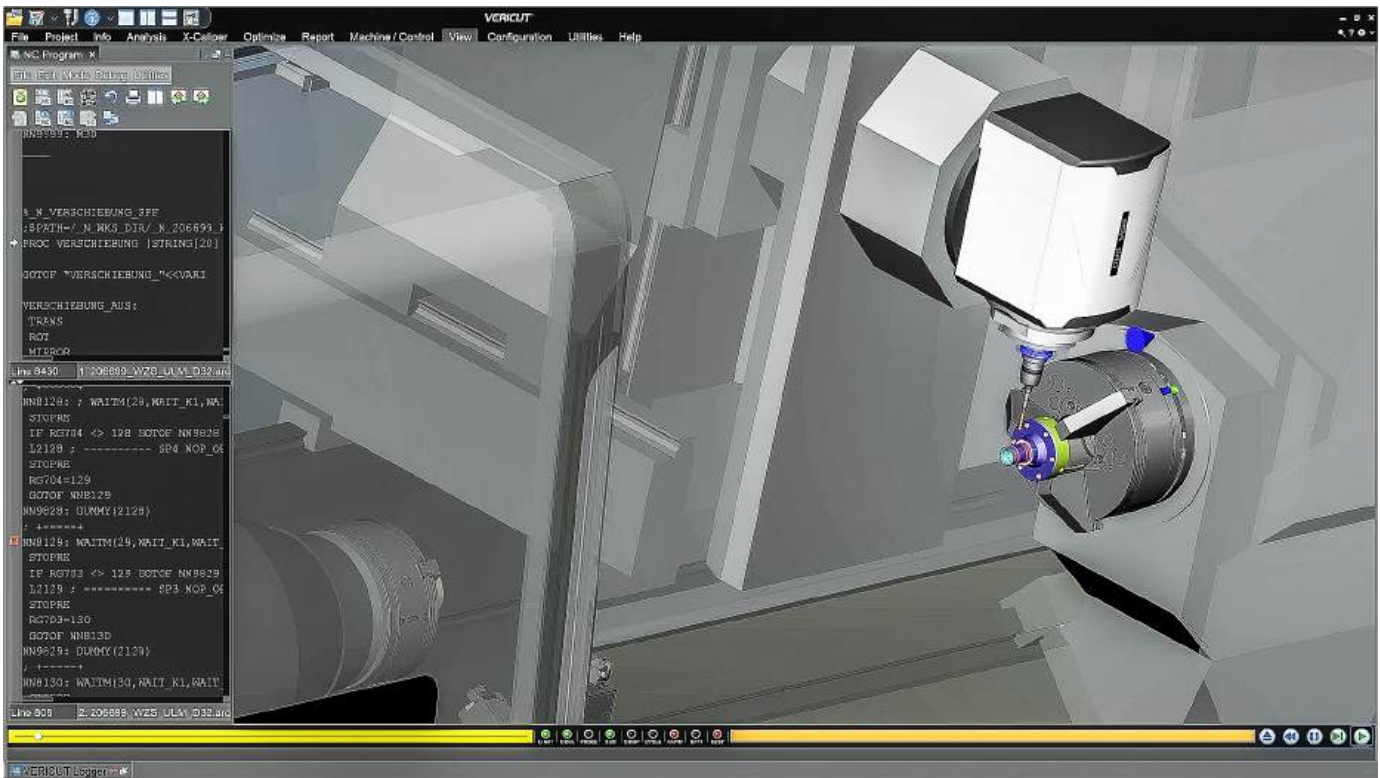

Since the introduction of Vericut, collisions at Schunk have been eliminated, minimizing downtime and unnecessary costs.